

Directional poppet valves bidirectional

Type WVH-4B-Bi

NG 4 Bieri

up to 12 l/min, up to **700 bar**

Features

- Directly operated
- Poppet tight
- Good corrosion resistance
- Bidirectional (flow in both directions, independent of pressure port)
- Low pressure drop
- Dead space optimized (for applications with grease)
- Compact
- Low weight



Applications

- Controlling of cylinders in higher pressure ranges as full replacement for spool valve technology (especially for seat tight holding and bending)
- In machine tools, hoisting technology, test stands and rescue devices
- Power units (e.g. as with limited space conditions or weight reduction)
- Use of high viscosity fluids / grease
- Use in lubrication systems

Design

- With hardened cones and seats
- 360° turnable and exchangeable plug-in coil
- Mounting on single subplates as "stand-alone" valves or in valve banks with subplates (see technical data sheets EAP-4B and APH/X-4B)
- As 2/2, 3/2 valve with solenoid actuation

Technical data

Hydraulic fluid	mineral oil according to DIN 51524 / Grease according to class NLGI 2
Fluid temperature range	-20 to 80 °C (down to -40 °C on request)
Ambient temperature range	-30 to 50 °C (down to -40 °C on request)
Viscosity range	5 mm ² /s to class NLGI 2
Porting	NG 4 according to Bieri standard
Max. operating pressure	700 bar
Max. flow rate / mass flow	12 l/min (Grease: approx. 2.5 kg/min)
Filtration (recommendation)	according NAS 1638 class 6 resp. ISO/DIN 4406 17/15/12
Duty cycle DC	100%
Solenoid voltage (nominal power)	24 VDC (27.2 W) / 110 VAC (25 W) / 230 VAC (25 W)
Voltage tolerance	+/- 10%
Switching time	40 - 120 ms
Degree of protection	IP 63 according to EN 60529 / DIN 40050 (IP 65 on request)
Weight	0,85 kg
Material	corrosion-resistant steel (coil housing: ZnFe - corrosion protection)

Type WVH-4B-Bi

NG 4 Bieri
up to 12 l/min, up to 700 bar

Type code

Example		WV	H	4B	2	/	2	WS	24	BI	V	A		00	
Directional poppet valves															Design 00 ... 99 For internal purposes
Size	700 bar														
Nominal size	4 ...														
Connection Bieri	... B														
Number of ports	2 or 3														Index Please leave blank For internal purposes
Number of positions	2														
Control function	See overview "Product informations"														
Control method	24 solenoid 24 VDC 110 solenoid 110 VAC 230 solenoid 230 VAC														
Technical design	Bidirectional														
Seal material	V FKM other seal materials on request														

Product information

Valve type	2/2		3/2 ¹⁾	
Control function	WO	WS	N	L
Part No. 24 VDC	4002620	4002624	4002628	4002628
Part No. 110 VDC	on request	on request	on request	on request
Part No. 230 VDC	on request	on request	on request	on request
Symbol				

¹⁾ **Attention:** Valve body needs to be turned 180° to change over control position N or L

To achieve function „L“, connection **3** (valve side) must be mounted to **P** (connecting plate), respectively connection **1** (valve) to **T** (plate). To achieve function „N“, connection **1** (valve side) must be mounted to **P** (connecting plate), respectively connection **3** (valve) to **T** (plate)

Dimensional drawings

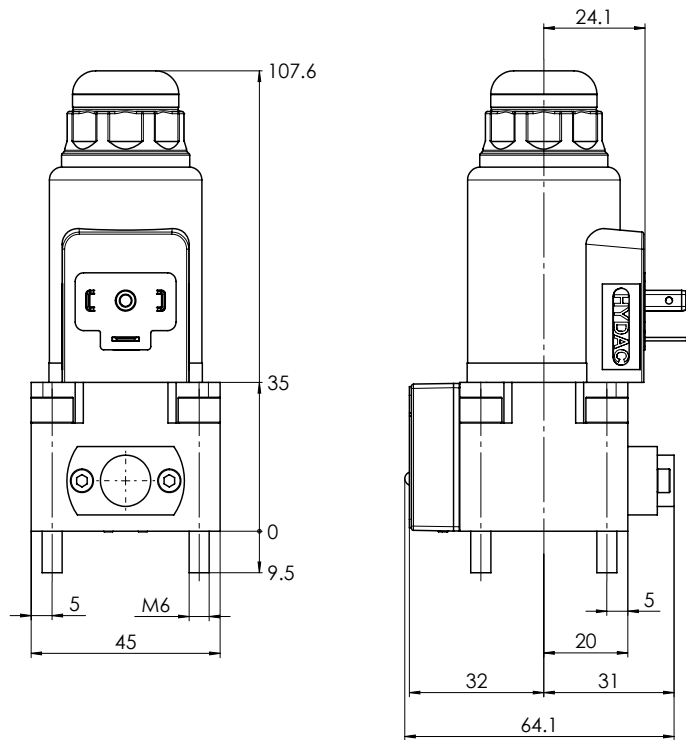

Manual override

F = 45 N

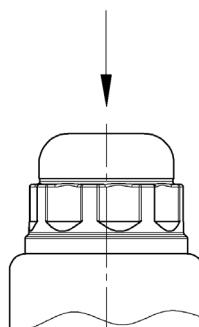

Drilling pattern 2/2 directional poppet valves

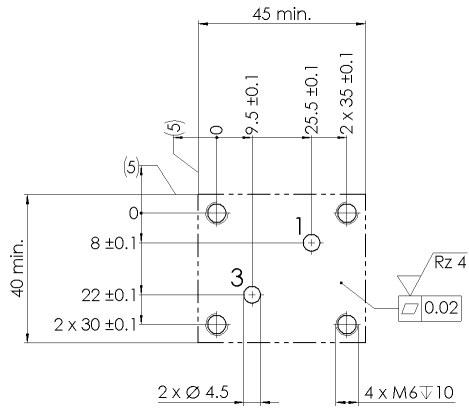

Drilling pattern 3/2 directional poppet valves

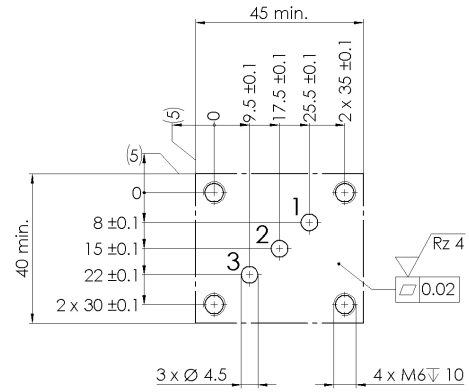

Pressure drop

($v = 32 \text{ mm}^2/\text{s}$)

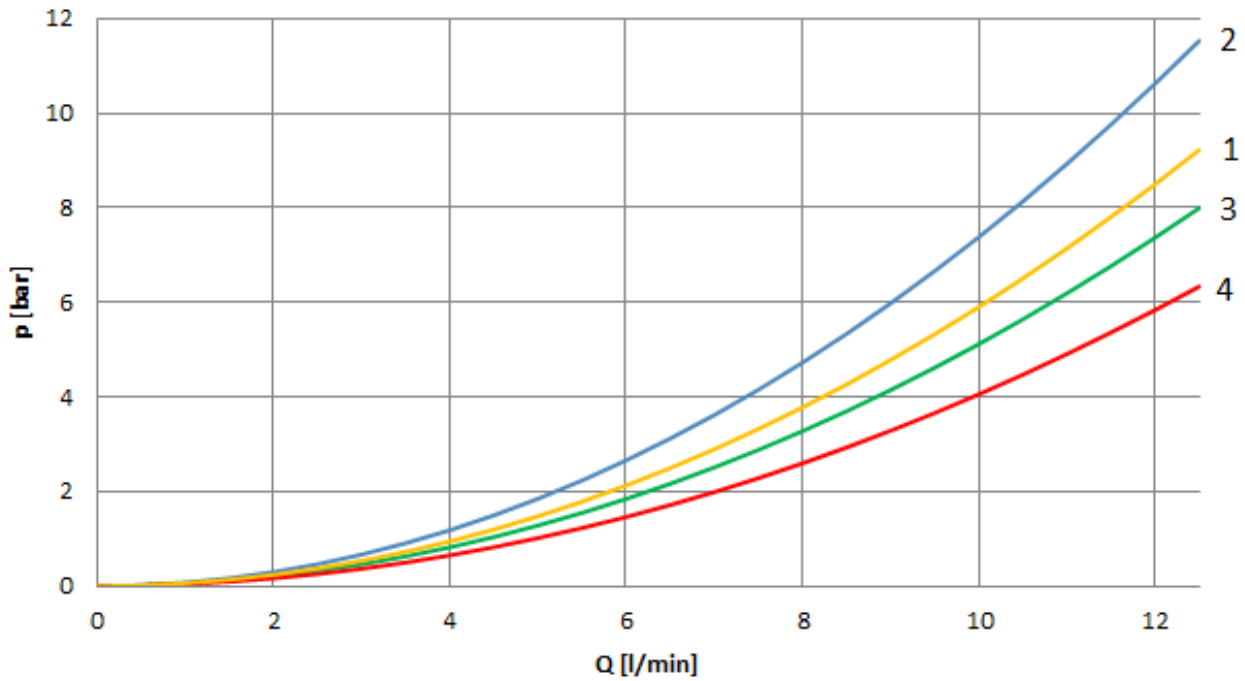

Valve type	Control function	1 - 2	2 - 1	2 - 3	3 - 2	1 - 3	3 - 1
2/2	WO					1	1
2/2	WS					1	1
3/2	L	2	4	3	2		
3/2	N	2	4	3	2		

Hydraulic switching capacity

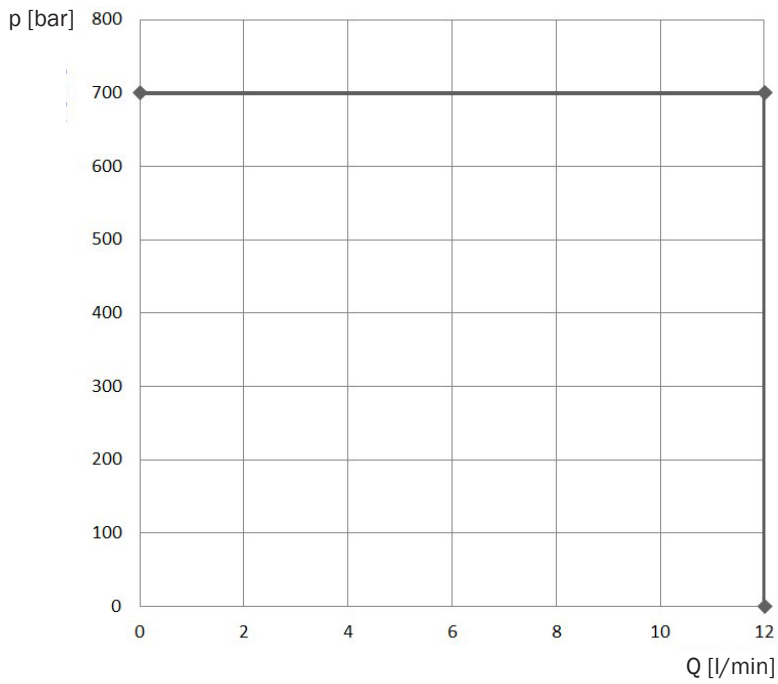

Hydraulic switching capacity at rated voltage and ambient temperature range $T_a = 50^\circ\text{C}$
 $v = 32\text{ mm}^2/\text{s}$

Applies to all control functions!

Operating voltage

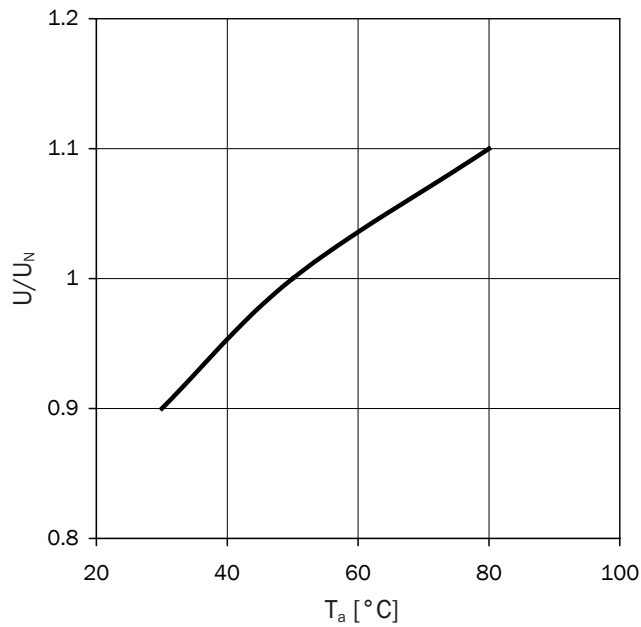

Operating voltage for reaching the hydraulic switching capacity at deviating ambient temperatures

Type WVH-4B-Bi

NG 4 Bieri
up to 12 l/min, up to 700 bar

Accessoires

Item description	Type code	For valve type	Part No.
Orifice insert Ø 0,4 (fitting in connection T)	BLM-4-0,4-A*00	All	on request
Orifice insert Ø 0,5 (fitting in connection T)	BLM-4-0,5-A*00	All	on request
Orifice insert Ø 0,6 (fitting in connection T)	BLM-4-0,6-A*00	All	on request
Orifice insert Ø 0,7 (fitting in connection T)	BLM-4-0,7-A*00	All	on request
Orifice insert Ø 0,8 (fitting in connection T)	BLM-4-0,8-A*00	All	on request
Orifice insert Ø 1,0 (fitting in connection T)	BLM-4-1,0-A*00	All	on request

* Orifice insert and check valves cannot be installed directly in the valve (**ZP700 required**).

Dimensional drawing

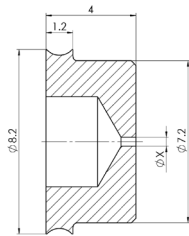

Symbol



Item description	Type code	For valve type	Part-Nr.
Adapter plate	ZP700-4-X-X-V-A*00	All	4400112
4 x socket head screw ISO 4762-M6 x 65 for ZP700	-	All	4362502

Item description	Type code	For valve type	Part No.
Check valve (fitting in connection P)	RVH700-4B-D6,5-X-A*00	2/2, 3/2-N	on request
Return pressure stop (fitting in connection T)	RDH700-4B-D6,5-X-A*00	2/2, 3/2-N	on request

Dimensional drawing

Check valve

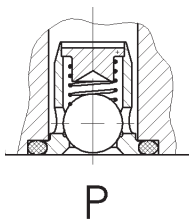

Return pressure stop

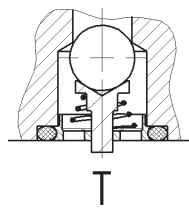

Symbol

Check valve



Return pressure stop



Type WVH-4B-BiNG 4 Bieri
up to 12 l/min, up to 700 bar

Item description	Part No.
1 x Plug for solenoid grey	6132484
1 x Plug for solenoid black	on request
1 x Power reduction plug LRS2 KPL Z4 TR 2POL LED	4747017

Spare parts

Item description	Part No.
3 x O-Ring 6,07 x 1,78, FKM	
1 x O-Ring 26,7 x 1,78, FKM	4477135
1 x O-Ring 17,96 x 2,62, FKM	
4 x Socket head screw ISO 4762-M6 x 35 - A2-70	4478218
1 x Solenoid 24 VDC	3546095
1 x Solenoid 110 VAC	3547372
1 x Solenoid 230 VAC	3547373
1 x Pole tube nut	on request
1 x O-Ring for pole tube nut	on request

Further fastening elements, tie bolts, subplates and single subplates please see technical data sheets APH/X-4B or EAP-4B.

Bieri Hydraulik AG

Könizstrasse 274
CH-3097 Liebefeld
Tel. +41 31 970 09 09 | Fax +41 31 970 09 10
info@bierihydraulics.com | www.bierihydraulics.com

The information in this brochure relates to the operating conditions and applications described.

For applications and operating conditions not described, please contact the relevant technical department.

Subject to technical modifications.